

SL3x-S LED Street light

Ordering Information

ESU-FA013P01640S-700FAU1-1112N

ESU	F	A01	2M	016	40	S	105
e-lite star LED Street Light	Product Series F – SL3x Series	Input Voltage A01 – 120~277 VAC	Lateral Light Distribution 2M – Type II Medium 3M – Type III Medium 3P – Type III Wide 5M – Type V Medium	LED Number 016 – 16 LEDs	Color Temperature 40 – 4000K	Luminaire Type S – 1-Modules	LED Driving Current 525 – 525 mA 700 – 700 mA 105 – 1050 mA 140 – 1400 mA

Specifications

100W HPS Equivalent

Type	SL3x-S			
Number of LEDs	16			
Luminous Flux (lm) (Typ.)	3569	4570	6367	7951
Power Consumption (W) (Typ.)	26	35	55	77
LED Driving Current (mA)	525	700	1050	1400
Efficacy (lm/W)	> 137	> 130	> 115	> 103
Light Distribution	Type II / Type III / Type III Wide / Type V			
Correlated Color Temperature (CCT) (K) (Typ.)	4000K			
Operating Voltage Range (VAC)	120 ~ 277			
Color Rendering Index (CRI) (Typ.)	≥ 70			
Power Factor (PF)	> 0.95			
Total Harmonic Distortion (THD) (%)	< 20%			
Operating Temperature Range	-40°F ~ +130°F			
Ingress Protection Classification	IP66 (for light engine)			
Material Characteristics	Aluminum Die Casting, UV Resistance PC			
Weight (lbs)	< 13			
Surge Protection	IEEE C62.41 C High (Max. Peak Current: 10KA)			
EPA	0.54			

Dimensions

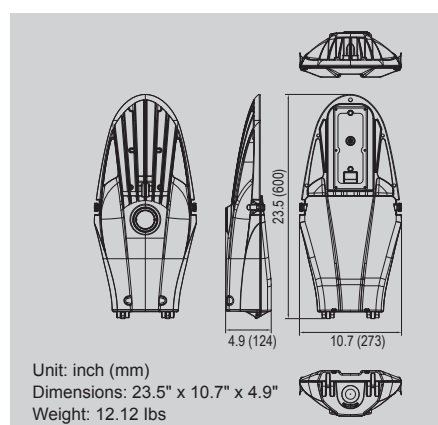

Photometric

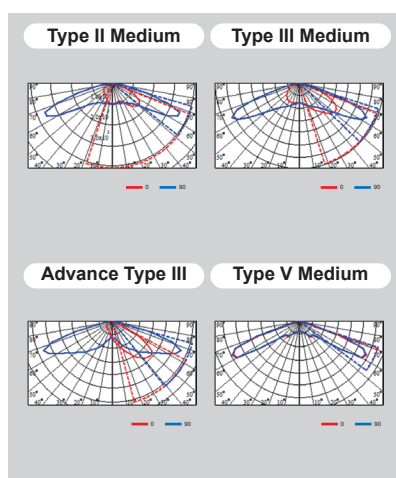

Isotropic Illumination Distribution

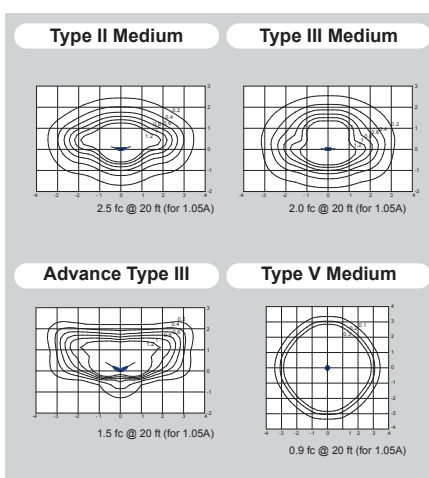

Product Certifications





SL3 LED Street light

Accessory Options

Ordering Information

LED Type	Finish	Safety Certificate	Door Entry	Dimmable Driver	Control Option	SPD Option	Additional Option
C – SL3c D – SL3s F – SL3x K – SL3x Mini	A – Gray B – Bronze I – Light Gray J – Black	U – UL	1 – Tool Less	1 – 0-10V	N – None 1 – 3-pin Receptacle 2 – Standard Photocell 3 – Shorting Cap 4 – Longlife Photocell 5 – 7-pin Receptacle	1 – 10kV/10kA 3 – 20kV/20kA 4 – 20kV/10kA FTO	N – None 1 – House Side Shield 2 – Bird Guard 3 – House Side Shield & Bird Guard 6 – 5' Pig Tail